



PROUD CANADIAN MANUFACTURER OF ARCHITECTURAL WINDOWS AND DOORS

Dalmen.com | 1 800-267-1747 | Info@dalmen.com





DALMEN WINDOWS AND DOORS

Proud Canadian Manufacturer with
Over 40 Years of Expertise and Quality



WHO WE ARE AND WHAT DO

With over 40 years in business, we've learned a thing or two. For instance, we understand that when you're looking for windows and doors, you're not just looking for eye-catching designs or performance. You're looking for reliable products that stand the test of time, delivering on form and function for unmatched and uncompromising quality.

Dalmen strives to create high-quality windows and doors that combine cutting-edge technology and design with respect for our heritage and where we've come from. We're very proud of the products we've created since we first opened our doors in 1973, and we are always looking at how we can improve and build upon what we've done before.

Located just outside of Ottawa, Ontario, Dalmen Windows and Doors is a proudly Canadian company serving customers from Ontario and Quebec. Whether you're looking for the latest styles to include in your design or are looking to source high-efficiency windows for a major project, we're ready to help you with a variety of amazing products.

**NO WINDOW IS TOO BIG, NO DOOR TOO SMALL—SIMPLY PUT,
WE'RE HERE TO HELP YOU BRING YOUR VISION TO LIFE.**



40 YEARS OF QUALITY

With over four decades in the business, Dalmen has developed exceptional products and practices that exceed expectations.



FAST DELIVERY SERVICE

We offer quick delivery services for clients in the Ottawa region and beyond, ensuring you get the products you need when you need them.



COMPLETELY CUSTOMIZABLE

Form and function should work hand in hand, which is why all Dalmen products can be customized to your needs and taste.



OUR HISTORY - SEE HOW FAR WE'VE COME!

- 1947** – Roger Menard relocates from Verdun, Quebec to St. Isidore, Ontario and purchases a wooden wheel factory. He transforms it into a cedar door and a pine wood window factory and begins distributing building materials under the name of J.R. Menard.
- 1950** – Roger is one of the main suppliers for the development of St. Lawrence Seaway in Cornwall, providing building materials, windows and doors, as well as cabinets.
- 1960** – Roger Menard (J.R. Menard) takes on projects in Ottawa and Hull and opens a roof trusses factory.
- 1970** – Roger Menard starts distributing doors and windows throughout Eastern Ontario and begins manufacturing steel roof claddings.
- 1973** – Roger's son, Jacques Menard, becomes the president of the company and builds a modern windows and doors factory. This marks the official start of DALMEN in the production of pine windows.
- 1980** – Jacques designs one of the first windows with outer PVC covers: The D2 Window.
- 1985** – Jacques and the Royal Group design a shutter entirely in PVC.
- 1990** – Jacques designs a D4 patio door.
- 1992** – Jacques introduces one of the first PVC windows that is solid and maintenance-free – COMFORT 2000. It will soon become the trendiest window in all of Eastern Ontario until 2001. COMFORT 2000 will also grab the attention of big distributors in the region (J. Lalonde et fils, J.R. Adams, Home Hardware).
- 2000** – Dominic Alary, an industrial engineer, joins the team to optimize operations and products.
- 2001** – Dominic introduces the Spectra window: a monocoque frame window with integrated brick molding.
- 2003** – Major automation investment is made to cut extrusions and weld windows with four-headed welders.
- 2005** – Investments are made for the manufacture of steel and fiberglass doors.
- 2010** – Expansion of Dalmen factory: production operations now take place in a 70,000 square feet facility.
- 2013** – Major investment in thermos glass production with automated equipment for glass cutting and assembly (without human manipulation) for highest quality. Thermos uses state-of-the-art Super Spacer and FOREL technology.
- 2015** – Start of the DalmenPRO trademark for distributors who have their own installers. Chris Papineau is the first franchisee of Dalmen PRO Ottawa. He has more than 15 years in sales and residential installation and multistage.
- 2016** – Dalmen manufactures and installs aluminium windows and curtain walls for commercial application.
- 2017** – Dalmen begins manufacturing GAMMA SLIM LINE all-aluminum windows for the commercial market and high-end residences with large format architectural windows.
- 2018** – The Dalmen PVC GAMMA window with core is the first window to pass the Flame Spread Index test for multi-storey buildings.
- 2019** – Dalmen starts manufacturing TILT & TURN EUROPA windows. This window will earn the PASSIVE HOUSE (Passivhaus) certification.



GAMMA, UNICA, AND EUROPA WINDOWS

Unmatched Strength, Durability, and Style

HIGH-PERFORMANCE WINDOWS FOR EVERY NEED AND STYLE

Whether you're looking for low-profile slimline frames, high-performance durable hybrid styles, or unmatched European designs ready for Canadian climates, we've got a window for you. Dalmen's range of Gamma, Unica, and Europa windows offer dependable and reliable performance you can count on, no matter your needs. These aluminum interior frames are a Dalmen specialty and can be ordered in a wide variety of custom colours for any design.

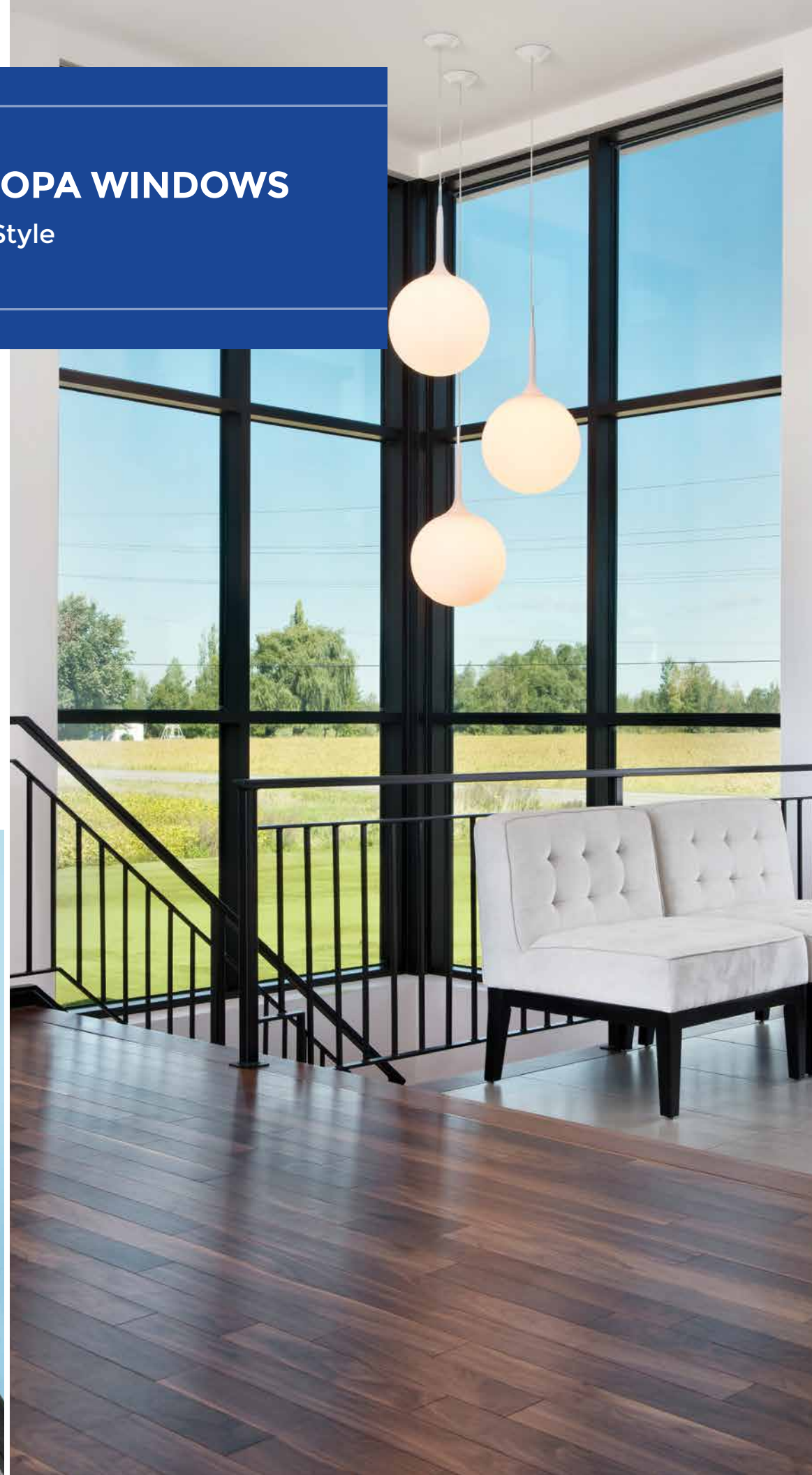
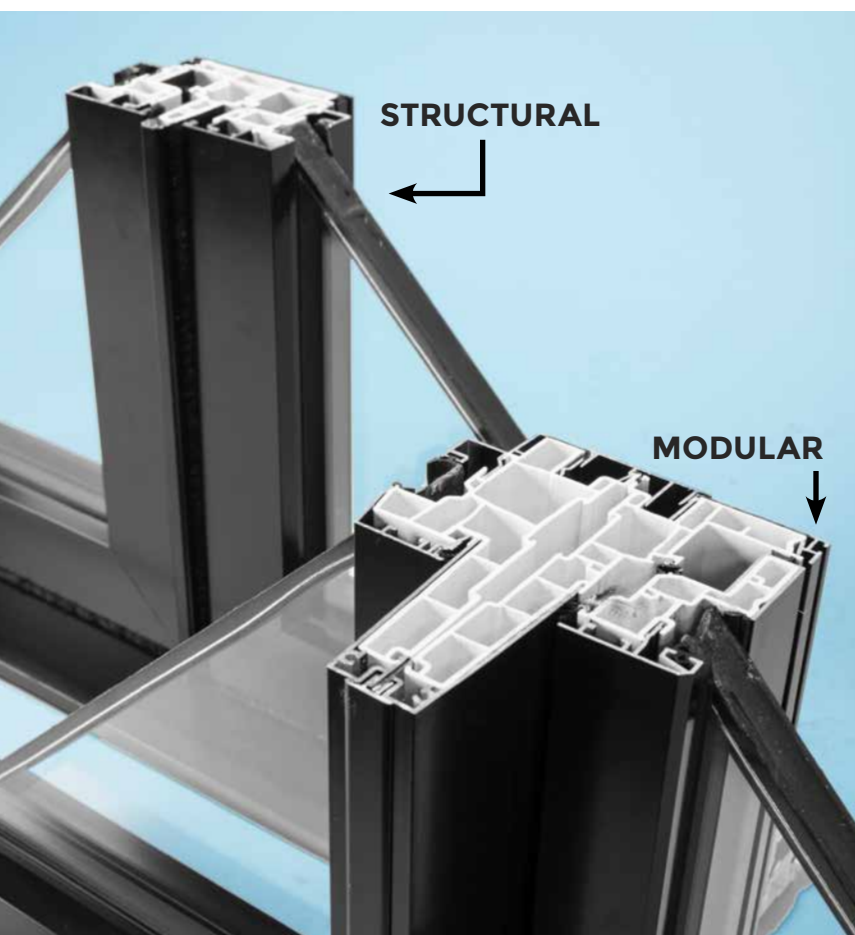

UNICA

UNICA WINDOWS MORE STRENGTH

Dalmen's Unica line achieves NAFS-11 Commercial Window classification for commercial, mid-rise, institutional, and special residential applications. These aluminum-clad vinyl frames provide unmatched strength for larger glass windows without sacrificing the thermal benefits of a multi-chamber vinyl window. Best of all, like Gamma, Unica windows can be customized as needed, giving you the option for aluminum interiors and totally unique colours for modern looks and styles.



GAMMA

— SLIMLINE —

GAMMA SLIMLINE WINDOWS MORE GLASS, LESS FRAME

Our Gamma Slimline windows offer European styling built for a Canadian climate. These windows are designed to last longer without sacrificing the performance you've come to expect. These windows feature stunning low-profile vinyl/aluminum hybrid frames that can be customized to any application. Best of all, Gamma windows offer leading Energy Star®-rated performance, all at an affordable price.



EUROPA

— EUROSTYLE WINDOWS —

EUROPA OPEN-IN BALCONY DOOR STYLE WINDOWS EUROPEAN STYLE DESIGNED FOR CANADIAN CLIMATES

The ultimate Eurostyle window, Europa offers versatile open-in functionality for wide openings with the low-profile frames and durability you've come to expect from Dalmen. These amazing windows are brand-new for 2019, perfect for creating stunning views in any building without sacrificing functionality and performance.





ALL PVC OR HYBRID - STRONGER FRAMES AND WINDOWS - BUILT TO LAST

Unica windows are the most efficient hybrid windows on the market, providing the same impressive energy efficiency you expect with sturdy, durable frames that are built to last. Unica windows make it possible to create those stunning wall-to-wall views that capture your attention as you enter a room, all designed with European styling in mind, adapted to our uniquely Canadian climate.

Our triple-glazed Unica windows have been engineered to keep the cold out and the heat in, using the latest glass from Saint Gobain to keep the heat in when temperatures drop and limit the effects of sunlight in the dog days of summer.

As with every Dalmen product, you can expect leading Energy Star®-rated performance and quality when you choose Unica hybrid windows.

EXTRUDED ALUMINUM FINISH INSIDE, BLACK AND SLATE OR CUSTOM COLOURS AVAILABLE

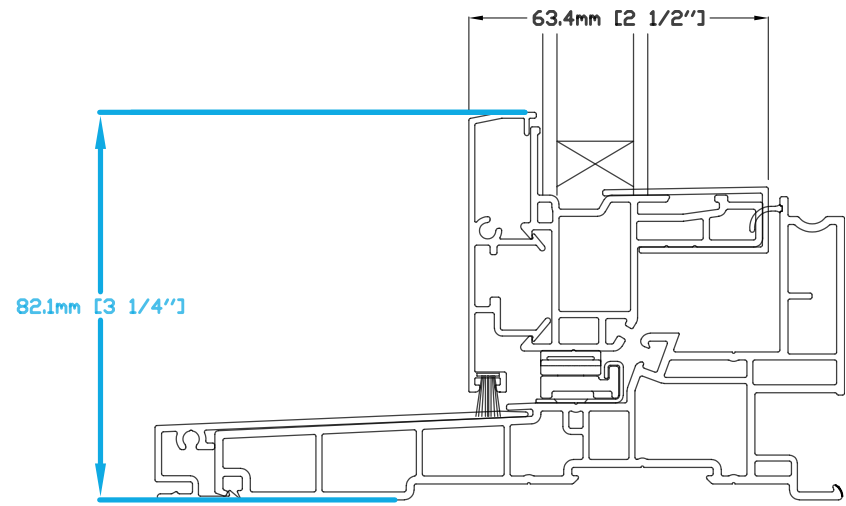



STRONG FRAMES YOU CAN COUNT ON







FULLY CUSTOMIZABLE PRODUCTS

Because of our unique manufacturing process and the technology we use, we're able to provide an unmatched level of customizability in the windows and doors we produce. From stunning colour options that won't fade over time to unique styles and custom-made architectural window features, Dalmen Windows and Doors has you covered.

UNICA WINDOWS ARE AVAILABLE IN ANY SIZE YOU NEED!

COLOURS

INTERIOR   **+ CUSTOM COLOURS AVAILABLE**

EXTERIOR      

GENTEK BLACK SLATE SABLE GRAPHITE ANODIZING STEEL COMMERCIAL BROWN

*Powder-coated Duranor from PPG Paint Div. - Hybrid Only



GAMMA

— SLIMLINE —

MORE GLASS, LESS FRAME

Gamma Slimline windows pair modern European low-profile frames with high-quality glass to maximize energy efficiency for smart eco-friendly designs that last.

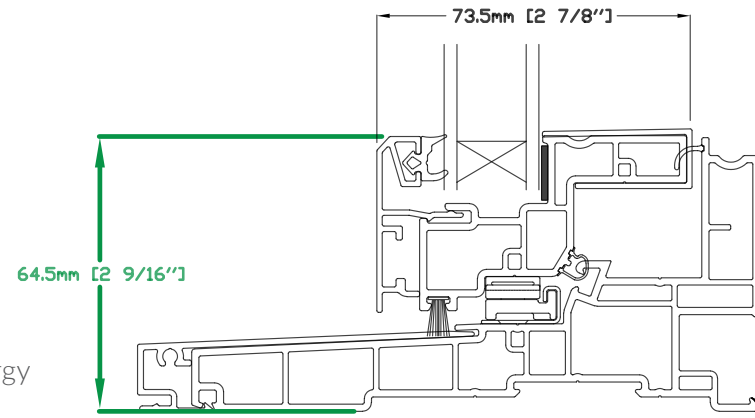

Gamma Slimline windows feature the latest energy efficient glass from Saint-Gobain: PLANITHERM. Planitherm uses proprietary production techniques and technology to capture free energy from sunlight, retaining more heat in the home on cold days. Our triple-glazed Gamma Slimline windows have been engineered to keep the cold out and the heat in, maximizing solar gain for a northern Canadian climate.

Gamma is fully customizable to your needs and features an all-PVC gloss finish, the option for aluminum interiors and exteriors, and has been designed to meet and exceed European performance standards, delivering leading Energy Star®-Rated Performance at a price that won't break the bank.

EXTRUDED ALUMINUM FINISH INSIDE, BLACK AND SLATE OR CUSTOM COLOURS AVAILABLE



BUILT TOUGHER, LASTS LONGER, AND PROTECTS BETTER







FULLY CUSTOMIZABLE PRODUCTS

Because of our unique manufacturing process and the technology we use, we're able to provide an unmatched level of customizability in the windows and doors we produce. From stunning colour options that won't fade over time to unique styles and custom-made architectural window features, Dalmen Windows and Doors has you covered.

GAMMA WINDOWS ARE AVAILABLE IN ANY SIZE YOU NEED!

COLOURS

INTERIOR   + CUSTOM COLOURS AVAILABLE

EXTERIOR      

GENTEK BLACK SLATE SABLE GRAPHITE ANODIZING STEEL COMMERCIAL BROWN

*Powder-coated Duranor from PPG Paint Div. – Hybrid Only

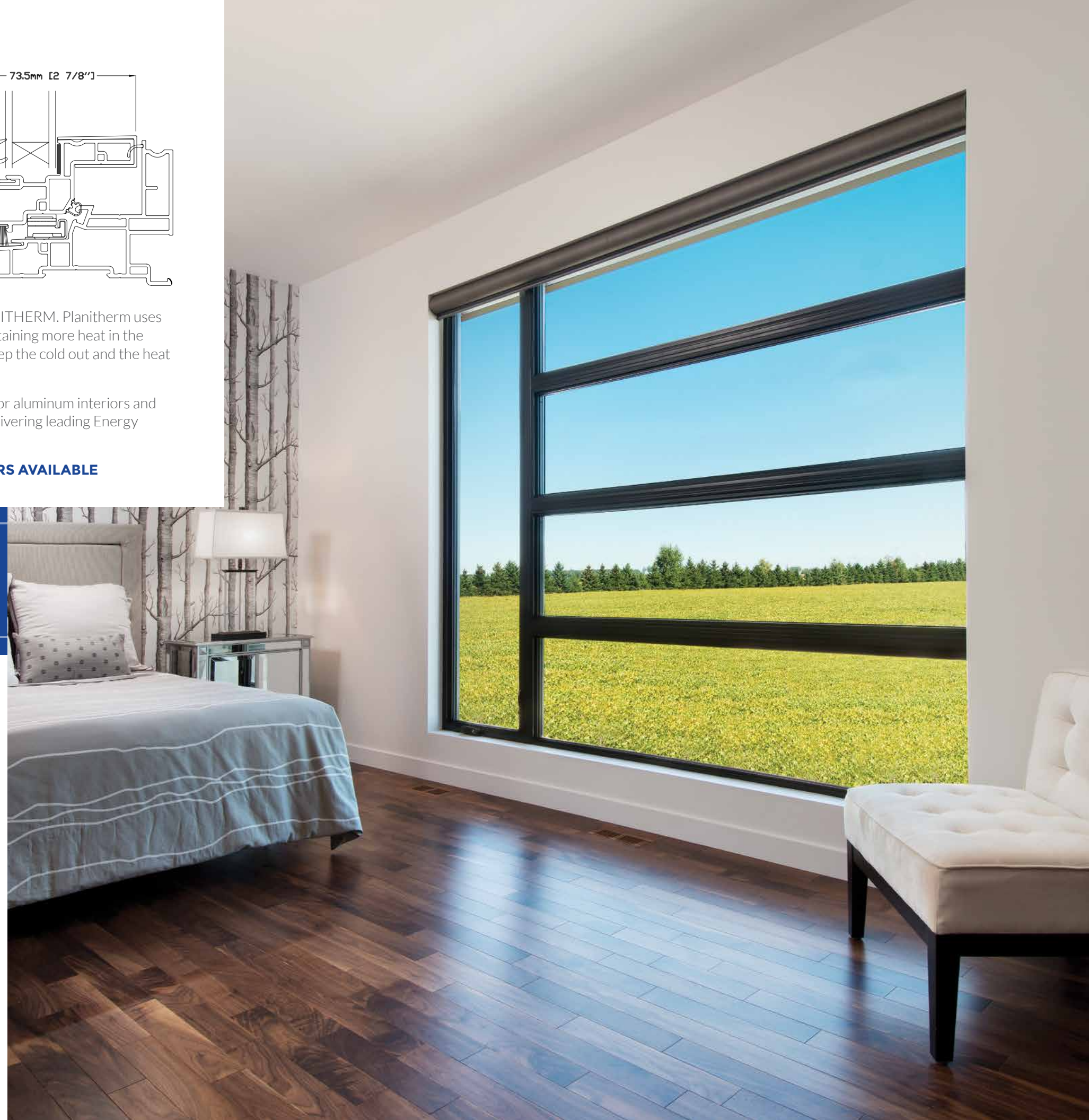

EUROPA

— EUROSTYLE WINDOWS —

UNIQUE EUROSTYLE WINDOWS BUILT FOR USE IN CANADA

Open-in windows are the standard by which all other designs are measured. Highly popular in Europe, these windows are now getting attention from architects, designers, and homeowners looking for the latest styles and impressive energy efficiency.

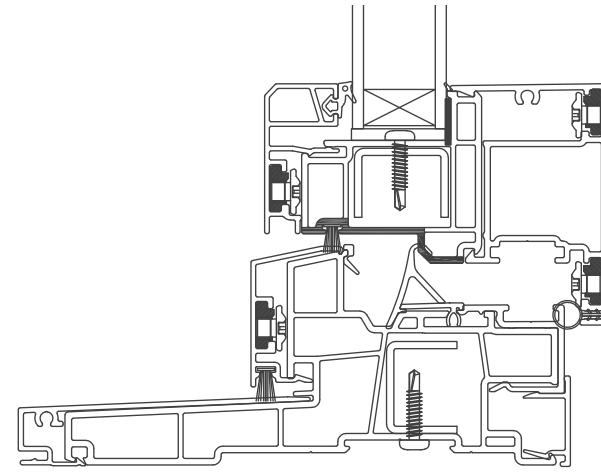

Europe has long been the world leader for energy efficient window products, creating stunning, modern designs that pair low-profile frames and open-in functionality for big openings with high-quality glass coatings and glazes for uncompromising style and performance in a beautiful package.

To date, these windows haven't been widely available in North America - which is where Dalmen's EUROPA windows come in.

Europa pairs the performance you've come to expect from Dalmen's window products with stunning Eurostyle designs. What you're left with is unmatched functionality ready for work in Canadian climates with beautiful styles and designs.

EXTRUDED ALUMINUM FINISH INSIDE, BLACK AND SLATE OR CUSTOM COLOURS AVAILABLE









BALCONY-STYLE WINDOWS FOR BIG OPENINGS

FULLY CUSTOMIZABLE PRODUCTS

Because of our unique manufacturing process and the technology we use, we're able to provide an unmatched level of customizability in the windows and doors we produce. From stunning colour options that won't fade over time to unique styles and custom-made architectural window features, Dalmen Windows and Doors has you covered.

EUROPA WINDOWS ARE AVAILABLE IN ANY SIZE YOU NEED!

COLOURS

INTERIOR			+ CUSTOM COLOURS AVAILABLE			
EXTERIOR						
GENTEK	BLACK	SLATE	SABLE	GRAPHITE	ANODIZING STEEL	COMMERCIAL BROWN

*Powder-coated Duranor from PPG Paint Div. - Hybrid Only

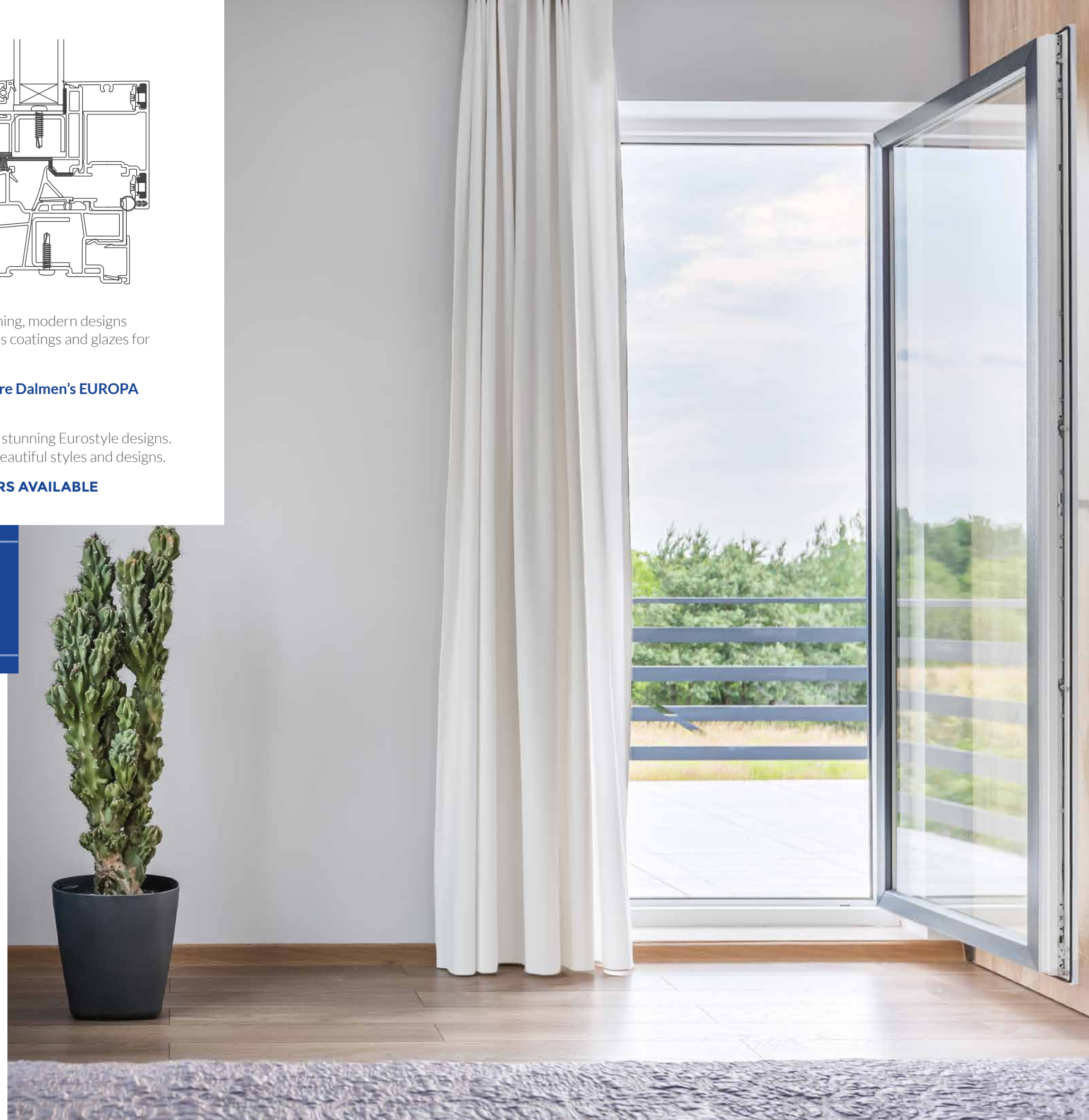

HOW DALMEN STACKS UP

DISCOVER THE MOST EFFICIENT WINDOWS ON THE MARKET

Learn more about why Dalmen Windows & Doors is widely regarded as a manufacturer of the most efficient products on the market and see how our windows compare to each other. Our impressive results and performance speak for themselves. Looking for an amazing view of the world around you, but want windows that'll handle warm Canadian summers and chilly winters? Look no further!

UNICA PVC WINDOWS

CPD	ENERGI SERIES: UNICA PVC	GLASS PAKAGE	U-Factor	SHGC	U-Factor Metric	Air Leakage (l/s/m ²)	ER	*2015 E-Star (ER)	**2022 Energy Act	**2025 Energy Act	**2030 Energy Act
DAL-M-46-00023-00001	4600 PVC (Batt-FX Batt)	2 GLAZE, 1 LOWE, ARGON	0.27	0.45	1.5	0.03	32	Z2	Yes	No	No
DAL-M-46-00047-00001	4600 PVC (Batt-FX Batt)	2 GLAZE, 2 LOWE, ARGON	0.23	0.43	1.3	0.03	34	Z3	Yes	Yes	No
DAL-M-46-00086-00001	4600 PVC (Batt-FX Batt)	3 GLAZE, 2 LOWE, ARGON	0.18	0.4	1.0	0.03	36	Z3	Yes	Yes	No
DAL-M-46-00089-00001	4600 PVC (Batt-FX Batt)	3 GLAZE, 2 LOWE, KRIPTON	0.17	0.4	1.0	0.03	36	Z3	Yes	Yes	No

UNICA HYBRID H1 WINDOWS

CPD	ENERGI SERIES: UNICA HYBRID H1	GLASS PAKAGE	U-Factor	SHGC	U-Factor Metric	Air Leakage (l/s/m ²)	ER	*2015 E-Star (ER)	**2022 Energy Act	**2025 Energy Act	**2030 Energy Act
DAL-M-48-00018-00001	4600 H1 Batt-Batt fx (L4623F)	2 GLAZE, 1 LOWE, ARGON	0.27	0.46	1.53	0.1	33	Z2	Yes	No	No
DAL-M-48-00019-00001	4600 H1 Batt-Batt fx (L4623F)	2 GLAZE, 2 LOWE, ARGON	0.24	0.42	1.36	0.1	34	Z3	Yes	Yes	No
DAL-M-48-00093-00001	4600 H1 Batt-Batt fx (L4623F)	3 GLAZE, 2 LOWE, ARGON	0.19	0.4	1.08	0.1	39	Z3	Yes	Yes	No
DAL-M-48-00094-00001	4600 H1 Batt-Batt fx (L4623F)	3 GLAZE, 2 LOWE, KRIPTON	0.18	0.4	1.02	0.1	41	Z3	Yes	Yes	Yes

UNICA HYBRID H2 WINDOWS

CPD	ENERGI SERIES: UNICA HYBRID H2	GLASS PAKAGE	U-Factor	SHGC	U-Factor Metric	Air Leakage (l/s/m ²)	ER	*2015 E-Star (ER)	**2022 Energy Act	**2025 Energy Act	**2030 Energy Act
DAL-M-48-00055-00001	4600 H2 Batt-Batt fx (L4623F)	2 GLAZE, 1 LOWE, ARGON	0.31	0.46	1.76	0.1	28	Z1	Yes	No	No
DAL-M-48-00056-00001	4600 H2 Batt-Batt fx (L4623F)	2 GLAZE, 2 LOWE, ARGON	0.27	0.42	1.53	0.1	31	Z2	Yes	No	No
DAL-M-48-00071-00001	4600 H2 Batt-Batt fx (L4623F)	3 GLAZE, 2 LOWE, ARGON	0.22	0.38	1.25	0.1	34	Z3	Yes	Yes	No
DAL-M-48-00100-00001	4600 H2 Batt-Batt fx (L4623F)	3 GLAZE, 2 LOWE, KRIPTON	0.21	0.4	1.19	0.1	37	Z3	Yes	Yes	No

GAMMA HYBRID H1 WINDOWS

CPD	ENERGI SERIES: GAMMA HYBRID H1	GLASS PAKAGE	U-Factor	SHGC	U-Factor Metric	Air Leakage (l/s/m ²)	ER	*2015 E-Star (ER)	**2022 Energy Act	**2025 Energy Act	**2030 Energy Act
DAL-M-57-00001-00004	H1-4600" Ext. Glazed Casement / Fixed Casement	2 GLAZE, 1 LOWE, ARGON	0.3	0.5	1.7	0.15	31	Z2	Yes	No	No
DAL-M-57-00014-00010	H1-4600" Ext. Glazed Casement / Fixed Casement	2 GLAZE, 2 LOWE, ARGON	0.26	0.46	1.48	0.15	34	Z3	Yes	Yes	No
DAL-M-57-00022-00010	H1-4600" Ext. Glazed Casement / Fixed Casement	2 GLAZE, 2 LOWE, ARGON	0.26	0.48	1.48	0.15	35	Z3	Yes	Yes	No
DAL-M-57-00012-00010	H1-4600" Ext. Glazed Casement / Fixed Casement	3 GLAZE, 2 LOWE, ARGON	0.2	0.41	1.14	0.15	38	Z3	Yes	Yes	No
DAL-M-57-00027-00010	H1-4600" Ext. Glazed Casement / Fixed Casement	3 GLAZE, 2 LOWE, KRIPTON	0.19	0.44	1.08	0.15	41	Z3	Yes	Yes	Yes

GAMMA HYBRID H2 WINDOWS

CPD	ENERGI SERIES: GAMMA HYBRID H2	GLASS PAKAGE	U-Factor	SHGC	U-Factor Metric	Air Leakage (l/s/m ²)	ER	*2015 E-Star (ER)	**2022 Energy Act	**2025 Energy Act	**2030 Energy Act
DAL-M-57-00001-00003	H2-4600" Ext. Glazed Casement / Fixed Casement	2 GLAZE, 1 LOWE, ARGON	0.3	0.5	1.7	0.15	31	Z2	Yes	No	No
DAL-M-57-00014-00011	H2-4600" Ext. Glazed Casement / Fixed Casement	2 GLAZE, 2 LOWE, ARGON	0.26	0.46	1.48	0.15	34	Z3	Yes	Yes	No
DAL-M-57-00022-00011	H2-4600" Ext. Glazed Casement / Fixed Casement	2 GLAZE, 2 LOWE, ARGON	0.26	0.48	1.48	0.15	35	Z3	Yes	Yes	No
DAL-M-57-00012-00011	H2-4600" Ext. Glazed Casement / Fixed Casement	3 GLAZE, 2 LOWE, ARGON	0.2	0.41	1.14	0.15	38	Z3	Yes	Yes	No
DAL-M-57-00027-00011	H2-4600" Ext. Glazed Casement / Fixed Casement	3 GLAZE, 2 LOWE, KRIPTON	0.19	0.44	1.08	0.15	41	Z3	Yes	Yes	Yes

EUROPA HYBRID H2 - INSWING HYBRID - DOUBLE GLAZE

CPD	ENERGI SERIES: EUROPA HYBRID H2	GLASS PAKAGE	U-Factor	SHGC	U-Factor Metric	Air Leakage (l/s/m ²)	ER	*2015 E-Star (ER)	**2022 Energy Act	**2025 Energy Act	**2030 Energy Act
-	GCL-ARG95-8070, SE	2 GLAZE, 1 LOWE, ARGON	0.30	0.50	1.7	0.02	32	Z2	Yes	No	No
-	8070-arg95-IS20, SE	2 GLAZE, 2 LOWE, ARGON	0.26	0.46	1.5	0.02	34	Z3	Yes	Yes	No
-	PTLUX-Arg-IS20 SE	2 GLAZE, 2 LOWE, ARGON	0.26	0.48	1.5	0.02	35	Z3	Yes	Yes	No

EUROPA HYBRID H2 - INSWING HYBRID - TRIPLE GLAZE

CPD	ENERGI SERIES: EUROPA HYBRID H2	GLASS PAKAGE	U-Factor	SHGC	U-Factor Metric	Air Leakage (l/s/m ²)	ER	*2015 E-Star (ER)	**2022 Energy Act	**2025 Energy Act	**2030 Energy Act
-	8070-ARG95-GCL-ARG95-S8070, SE	3 GLAZE, 2 LOWE, ARGON	0.20	0.42	1.1	0.02	39	Z3	Yes	Yes	No
-	PTLUX-Arg-Cir-Arg-PTLUX, SE	3 GLAZE, 2 LOWE, ARGON	0.20	0.44	1.1	0.02	41	Z3	Yes	Yes	Yes
-	PTLUX-Kry-Cir-Kry-PTLUX, SE	3 GLAZE, 2 LOWE, KRIPTON	0.19	0.44	1.1	0.02	42	Z3	Yes	Yes	No



BIG GLASS WINDOWS

WE MAKE BIG, BEAUTIFUL WINDOWS THAT TRANSFORM YOUR HOME

The concept is simple: large glass windows connect contemporary homes to the world around them in ways traditional styles cannot. This unbroken visual link to lakes, woodlands, and more anchors the home to its environment.

Dalmen Windows and Doors manufactures contemporary glass windows that give a fresh perspective and clear view of the world around you. With window options for every room, Dalmen's mastery of applied geometry makes it possible to reduce frame profiles while increasing the overall glass surface of every window, all without compromising strength and durability.

**SIMPLY PUT, OUR WINDOWS CONNECT YOU
WITH THE ENVIRONMENT.**

BE IN HARMONY WITH THE WORLD AROUND YOU

READY FOR THE 2025 ENERGY CODE

The Most Efficient Aluminum Hybrid Windows on the Market

FEATURES

- The GAMMA sash is 74mm wide by 41mm high (2 7/8" x 1 5/8"). The UNICA sash is 63mm wide by 59mm high (2 1/2" x 2 5/16"). The EUROPA sash is 74mm wide by 41mm high (2 7/8" x 1 5/8").
- Our windows are designed for 25mm (1") glazing, providing maximum glass area and dual glazing with flexibility for varying glazing packages. Triple glazing also available (1 1/4")
- Two continuous flexible weatherstrips and a pile exterior strip provide air- and water-tightness for operating windows
- A similar flexible weatherstrip seals to the exterior glass surfaces, minimizing water infiltration
- A positive interior air barrier creates a pressure balance with the exterior, allowing for efficient water drainage
- All PVC available in "Gloss Finish" 4 1/2" or 5 1/4" frame with contemporary sash
- The aluminum frame profiles are mechanically fastened with steel screws through integrated grooves for maximum strength
- The aluminum frames are available in 147mm (5 3/4") and/or 167mm (6 5/8") to accommodate varying wall designs and installation conditions
- The aluminum sash profiles are assembled with adjustable corner keys for a perfect fit and finish
- Screens can be removed from the inside

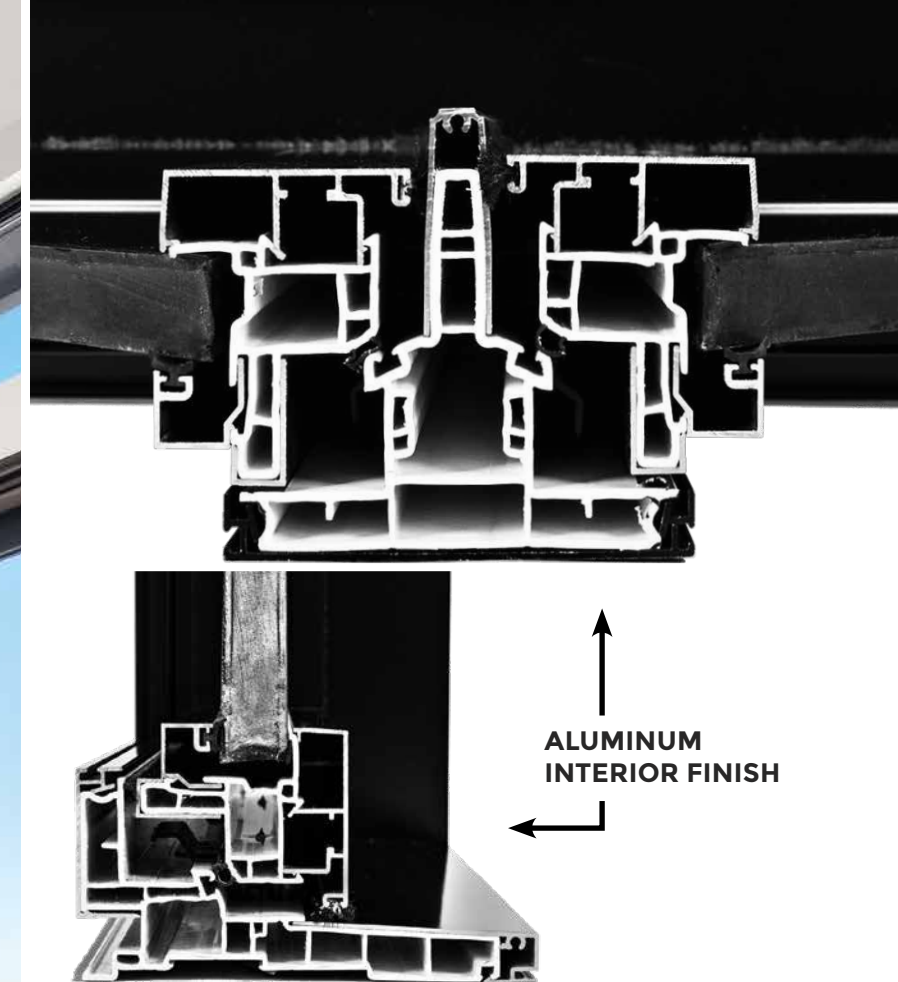

IMPRESSIVE PERFORMANCE

PRODUCT	
CASEMENT AND AWNING (PVC AND HYBRIDE)	
STANDARD A440-00	WIND LOAD C5
AIR INFILTRATION A3/F	WATER INFILTRATION B7
ENERGY RATING 33	NAFS-08 LC-PG75-C/LC-PG70-FW
FORCE ENTRY F20	

ENERGY STAR			
	DOUBLE GLASS 1 Low-E	DOUBLE GLASS 2 Low-E	TRIPLE GLASS 1 Low-E
ZONE	1 - 2	1 - 2 - 3	1 - 2 - 3
*U FACTOR RESULTS	1.59	1.42	1.14
ENERGY RATING	33	36	40

*Will vary according to type of glass selected - U value with no grills

INDUSTRY STANDARDS

- The vinyl profile window thermal insulation system is in accordance with AAMA-303 standard
- The aluminum extrusions are made of alloy and quench aluminum 6063- T5, in accordance with NAFS-08/11 standards
- The UNICA Window Series meets the requirements of AAMA/WDMA/ CSA101/ I.S.2/A440-11 standards
- UNICA and GAMMA exceed the SB-12 (Ontario Energy Code for Part 9 Buildings) S 3 points (LEED for Homes)

THE DALMEN SOLUTION

WARM UP YOUR LIFE

SUPER SPACER[®] SYSTEM

Super Spacer[®] is a dual seal insulating glass system. This NO-Metal, structural foam spacer clearly resists condensation, reduces energy costs, provides long-life durability and adds both comfort and value to your windows.

Super Spacer[®]

DIRECT FROM GERMANY

When it's nice and cold outside, it's still sunny but warm inside. The low emission Thermal LUX St-Gobain glass is specially engineered to keep warmth inside and maximize solar gain in northern climates.

SAINT-GOBAIN

Super Spacer®

SUPER SPACER® TECHNOLOGY - BEST IN CLASS

The Super Spacer® technology ensures three things: lower energy costs, the elimination of condensation, and prolonged durability. This dual seal insulating glass system is made from structural foam spacer containing absolutely no metal. Experience both comfort and value to your windows with Super Spacer®.

up to
+16.6°F/9.23°C
warmer temperature at the edge of the glass

Outside 0°F/-17.78°C ± 2°F/-16.67°C
Inside 70°F/21.11°C ± 2°F/-16.67°C

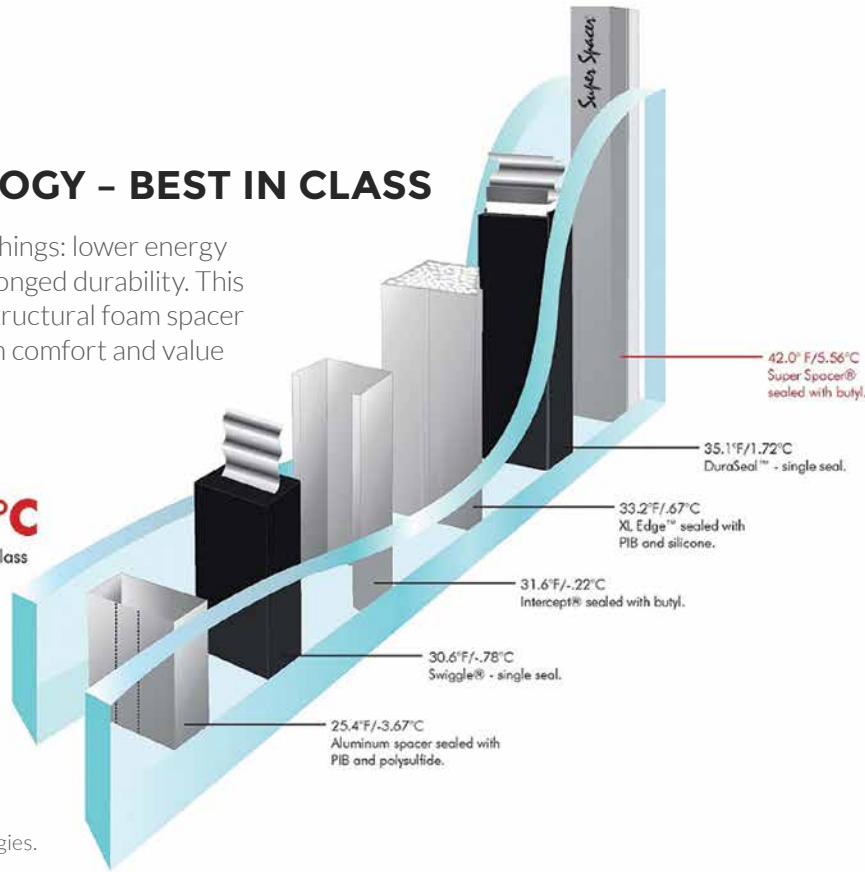

- Super Spacer® is a registered trademark of Edgetech.
- DuraSeal™ is a trademark of TruSeal Technologies.
- Intercept® is a registered trademark of PPG Industries.
- Swiggle® is a registered trademark of TruSeal Technologies.



SAINT GOBAIN GLASS

When it's nice and cold outside, it's still sunny but warm inside. The low emission 80/70 Saint Gobain glass is specially engineered to keep warmth inside and maximize solar gain in northern climates.

ULTRA-MODERN INSULATING GLASS FACTORY

Our state-of-the-art production plant is equipped with the very best and latest technology to allow Dalmen to offer insulating glass units of high-quality and performance.

OUR COMMITMENT TO YOU

We believe in providing exceptional products that, when optimally installed and cared for, will provide you with reliable performance for years to come. We're committed to excellence in all that we do.



PRICE



ENERGY EFFICIENCY



QUALITY



REPUTATION



WARRANTY



ENERGY-EFFICIENT GLASS YOU CAN TRUST

PLANITHERM® LUX LOW-E GLASS FROM GERMANY

In this day and age, energy efficiency is on everyone's mind. It's no longer just about keeping cool in the summer and warm in the winter—it's about keeping energy bills low and ensuring homes and buildings boast greater thermal efficiency. Windows are on the leading edge of this initiative, and Dalmen Windows and Doors is proud to offer Saint-Gobain's SGG Planitherm® LUX Glass glazing in all of our products.

Produced in Germany, these new Low-E coated glasses are dedicated to triple-glazed units for better comfort, no matter the window size.

Planitherm® LUX offers exceptional thermal insulation while maximizing passive solar gains:

Thermal Insulation: $U_g = 0.7 \text{ W/m}^2\text{K}$ | **Solar Gain:** $g = 62\%$

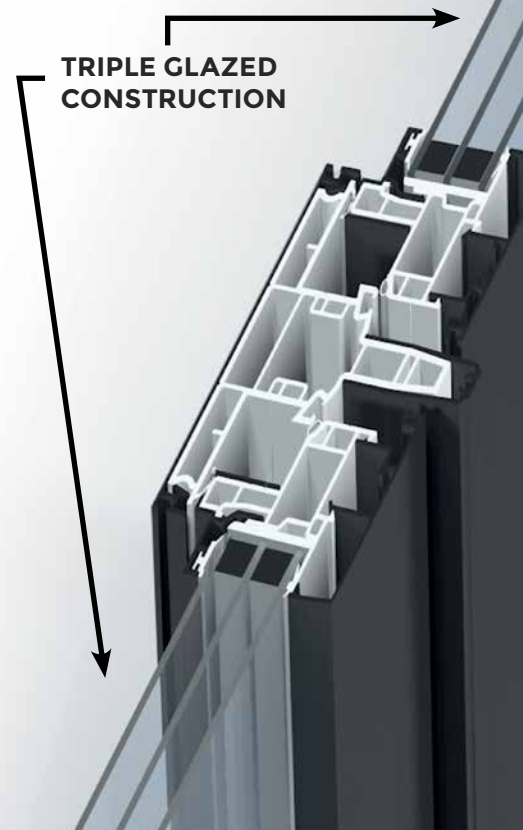

TRIPLE GLAZED CONSTRUCTION



BEAUTIFUL ALUMINUM INTERIOR FINISH

HOW IT WORKS

SGG Planitherm® LUX is manufactured on Saint Gobain Glass' magnetron coaters. A unique combination of multiple layers is applied to high-quality extra-clear float glass using a magnetically enhanced cathodic sputtering process under vacuum conditions. The resulting thin and extremely transparent coating reflects long-wave heat radiation (Low-E) back into the room, whilst maximizing transmittance of natural light and short-wave solar radiation.

Put simply, Planitherm® LUX keep you cool in summer and warm in winter!

APPLICATIONS

Planitherm® LUX glass ensures a high level of day lighting (with 73% light transmission on triple-glazed window units) alongside impressive energy efficiency, which are particularly effective for passive houses and low-energy homes and buildings—but that's not all.

Here's a sample of LUX's many potential applications:

Residential

- Windows
- Patio Doors
- French Doors
- External Doors

Commercial

- Facades and Windows
- Curtain Walling
- Structural Glazing

BIG WINDOWS THAT DON'T SACRIFICE PERFORMANCE

Embrace the Environment Around You With Big Windows By Dalmen

BEST-IN-CLASS PERFORMANCE

- **Transparency:** Enjoy natural lighting in any room, even on cloudy winter days.
- **Comfort:** Energy efficient performance means you're always comfortable sitting by a window.
- **Freedom:** Planitherm® LUX meets the needs of architects and designers looking to expand views.

TECHNICAL SPECIFICATIONS

	TGU with PTL LUX	
External Pane	SGG PLANITHERM LUX	
Middle Pane	SGG PLANILUX	
Internal Pane	SGG PLANITHERM LUX	
Composition in mm	36mm=4/12/4/12/4 or 40mm=4/14/4/14/4	
Spacers	2x12mm 90% Argon	2x14mm 90% Argon
Coating positions	Face 2 and 5	
TL*	73%	
RLe*	17%	
g-value*	0.62	
Ug-value in W/m2K**	0.8	0.7

* Light and solar performance according to EN 410
 ** Centre pane Ug-values in accordance with EN 673

WORK WITH THE SUN, NOT AGAINST IT

We Design Our Windows According to Your Home

Anyone who's spent a summer without air conditioning knows firsthand how big a role sunlight plays in the temperature of any room. The right windows can make a big difference, with energy efficient designs reducing solar heat gain in your home.

For example, our sealed glass units can help reduce how much heat gets into any room, and we manufacture each one onsite at our headquarters, instead of buying them from a mass-production supplier like so many other companies.

BUT IT'S NOT ALL ABOUT MATERIALS—IT'S HOW YOU USE THEM.

At Dalmen, we design windows that take the orientation of a building into account and how the sunlight hits the glass.

We make sure that in summer, you won't overheat, and in winter, you're able to reduce your energy bills.

For example, at the south-west, low-E double-glazed glass, such as a 70/36 grade on face 2, is optimal. When the sun goes down, the coating will help reduce heat gain. You can increase the U value by adding a low-E coating on surface 4 with our IS20 hard coat. This low-E coating on interior glass reflects heat radiation back inside in cooler weather, bringing comfort and savings.

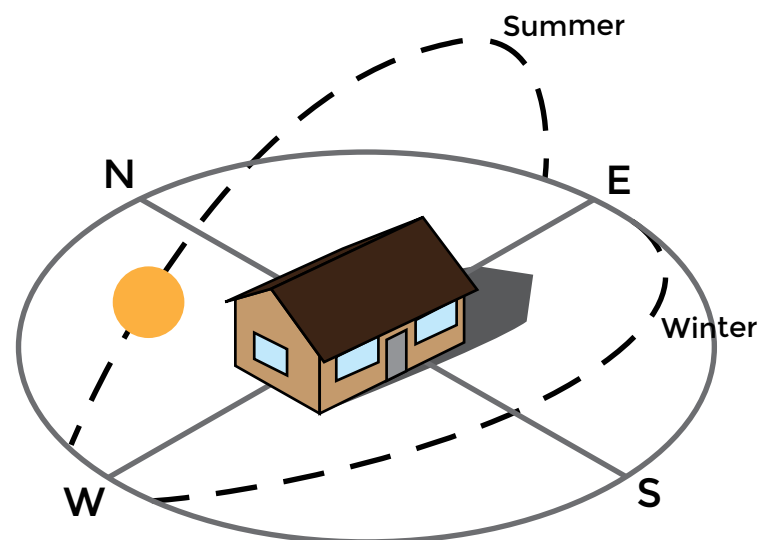

DALMEN'S DOORS

Discover Dalmen's Extensive Door Selection

DOORS

We're proud to carry a wide selection of doors for every need, including custom-made Dalmen doors and products from other leading manufacturers. From stunning contemporary designs to classic styles paired with modern features and reliability, no matter what you need in an entranceway, we've got you covered.

INTERIOR AND EXTERIOR DOORS

When you choose doors from Dalmen, your business is deciding to make a long-term investment in quality. Our products will last longer, enhance the desired look you want to sell, and are designed for all weather conditions. A beautifully designed door is nothing without correct measurements and specialized installation.

Novatech[®]

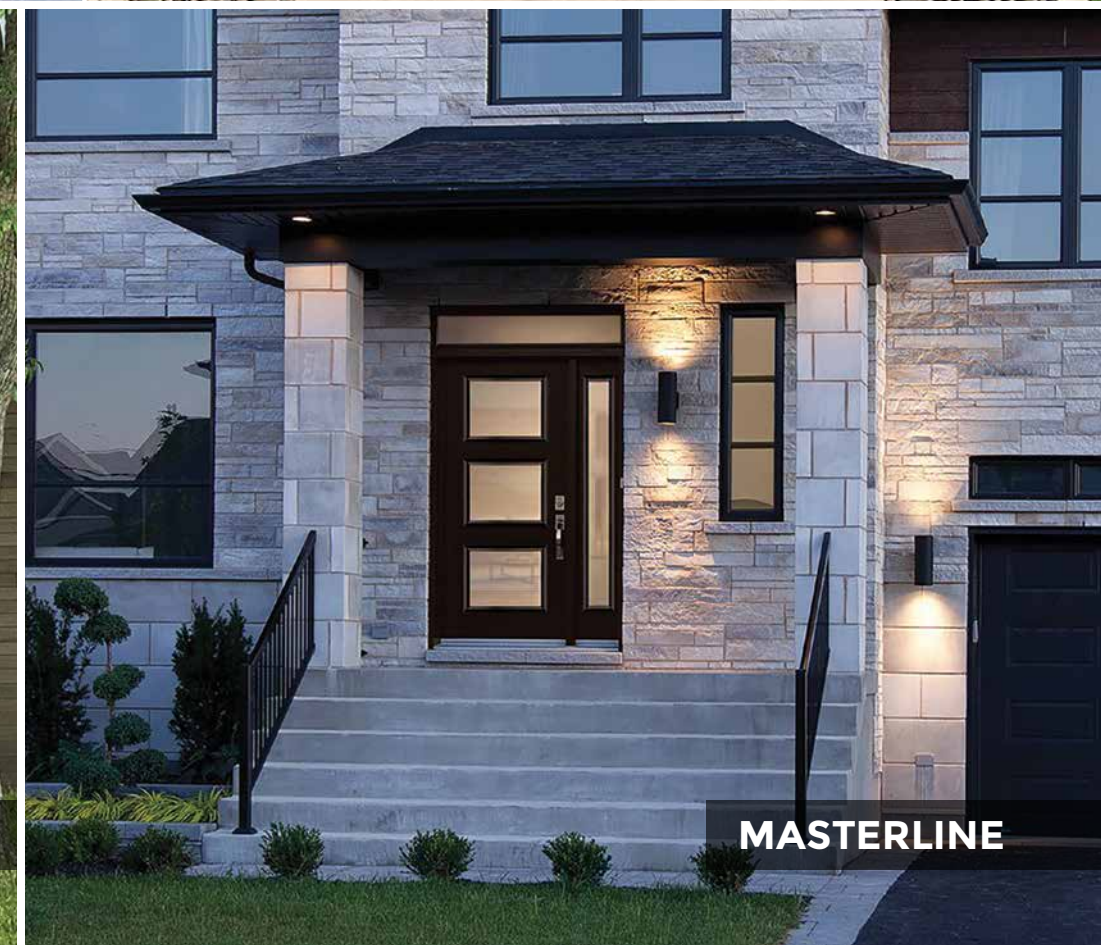
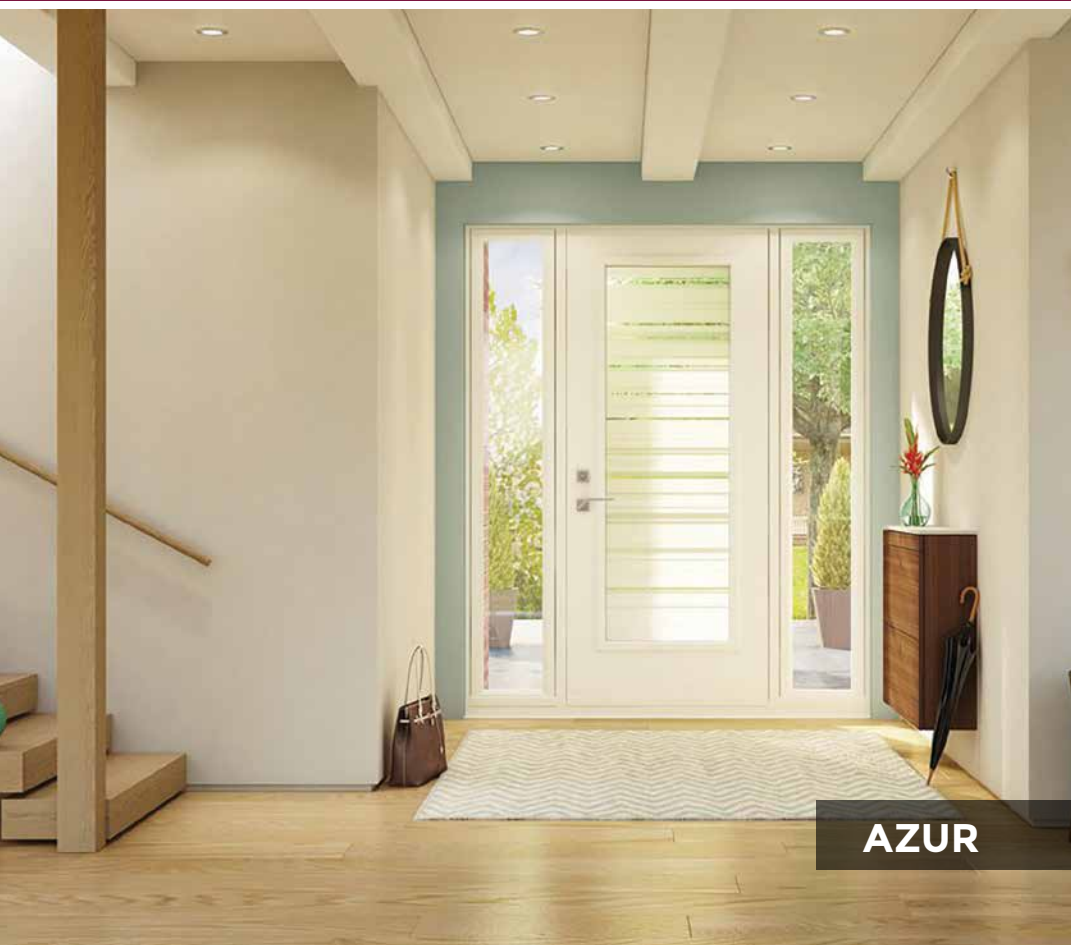

DALMEN'S PATIO DOORS

Discover Dalmen's Extensive Patio Door Selection

WE MAKE BIG PATIO DOORS - FROM 12' TO 24'

LIVE INSIDE OUT WITH DALMEN

We carry a full range of unique patio door options, including lift-and-slide patio doors, perfect for creating beautiful patio entrances without sacrificing your view. These doors slide beautifully into place where and when you need them, creating a contemporary glass-wall effect. We use Saint Gobain Planitherm® LUX glass in all our products, ensuring optimal energy efficiency, even on large glass doors.

LIFT-AND-SLIDE DOORS

SLIDE AND STACK DOORS



WIDE SELECTION OF MOULDING AND GRILL OPTIONS

Exterior mouldings add a special touch to your home while improving insulation.

FOR PVC CASEMENT, HUNG, AND SLIDING WINDOWS

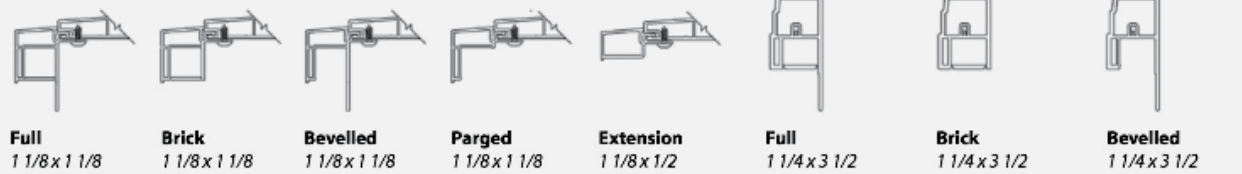

FOR HUNG AND SLIDING WINDOWS



FOR PVC CASEMENT AND AWNING WINDOWS

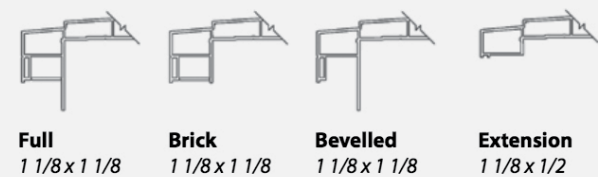

FOR HYBRID CASEMENT WINDOWS

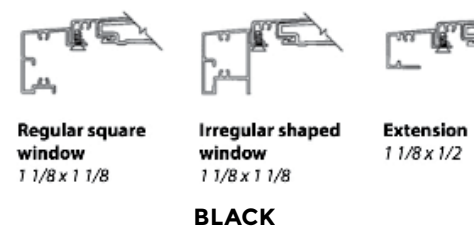

PAINT THAT WON'T FADE!

Looking for a special touch on your windows? We're ready to help you find the perfect shade for your frames! All paint at Dalmen Windows and Doors is applied in a controlled environment to ensure optimal surface adhesion through our wide variety of custom colours. Best of all, because of the quality of our paint process and how we treat our windows, your colours won't fade—and that's a guarantee!

ANY COLOUR YOU LIKE

Add a pop of colour to your home, setting off the stunning view of the world around you! Coloured frames are an exciting way to add additional flair to an already beautiful building. Live big, and try something different!



DURABLE HARDWARE

We provide stainless steel hardware, perfect for standing up to the elements wherever moisture can try to get in.

GRILL STYLES

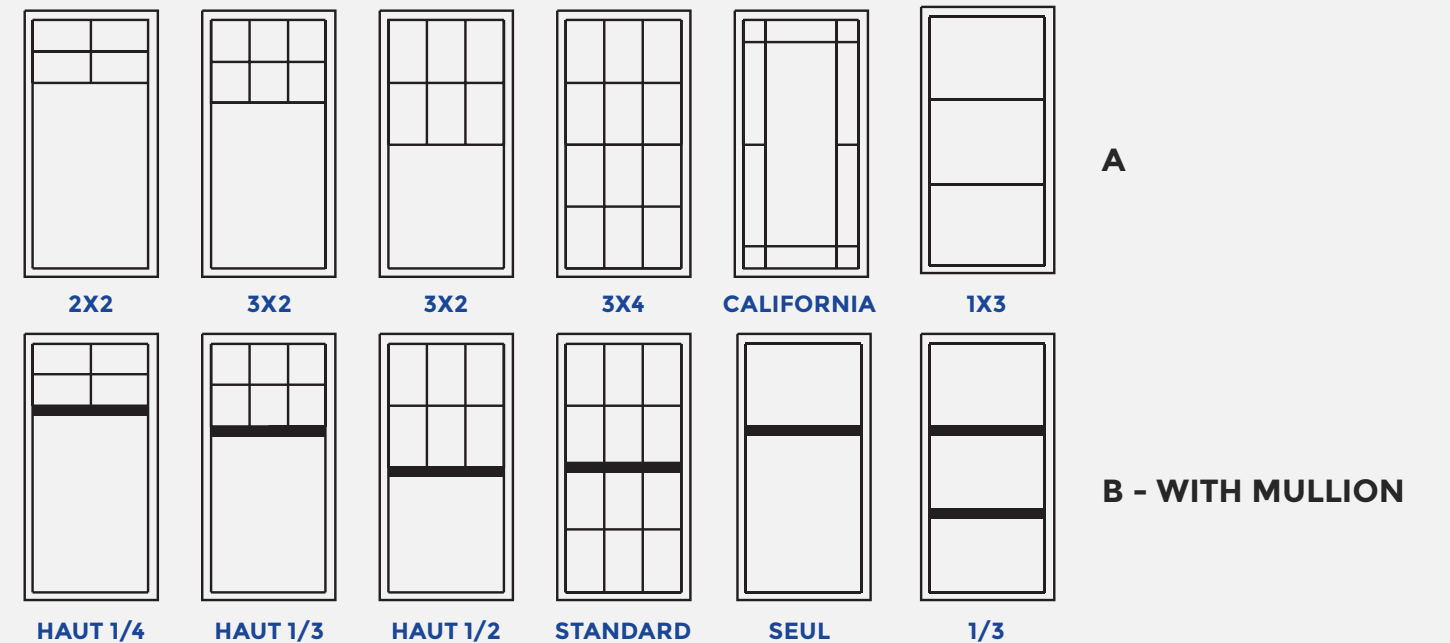

GRILL TYPES



CUTTING-EDGE TECHNOLOGY

At Dalmen Windows and Doors, we're always looking for ways to improve our products and how we create them. We use the latest technology to deliver exceptional products you can count on for years to come.

SEAMLESS PVC JOINT AND ZIPWELDING

Using the latest zip weld technology, Dalmen is able to create stunning, seamless welds on all our window and door frames. This creates a smooth, professional look, getting rid of frustrating fibers and material left on otherwise stunning windows. Our zip-welded windows are 6 times stronger compared to standard welds, delivering unmatched stability and durability to our already impressive frames.

We're very proud to be the first manufacturer in Canada to provide this Italian-inspired technology, offering a perfect finish for millwork-like detail that simply cannot be beat.

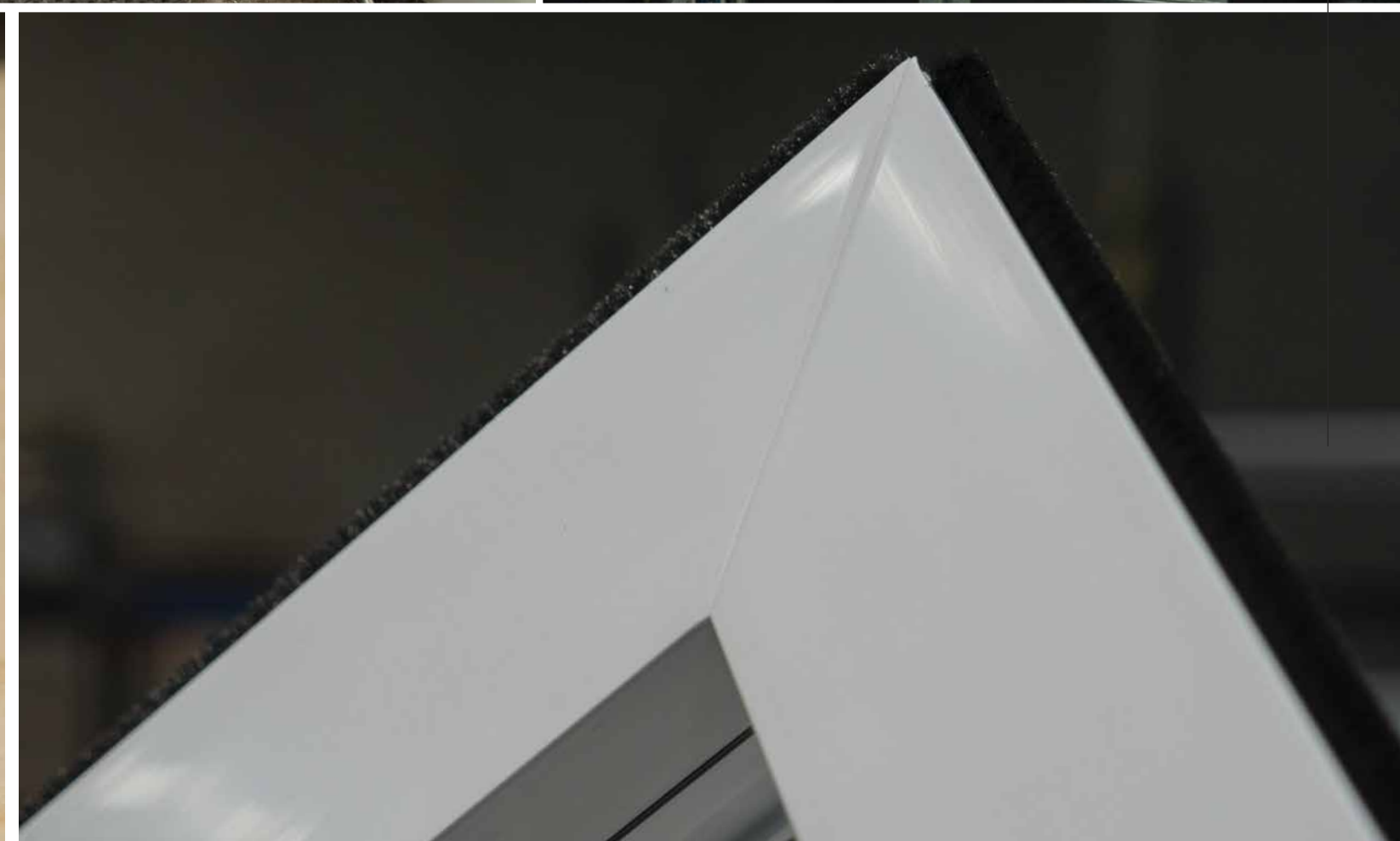
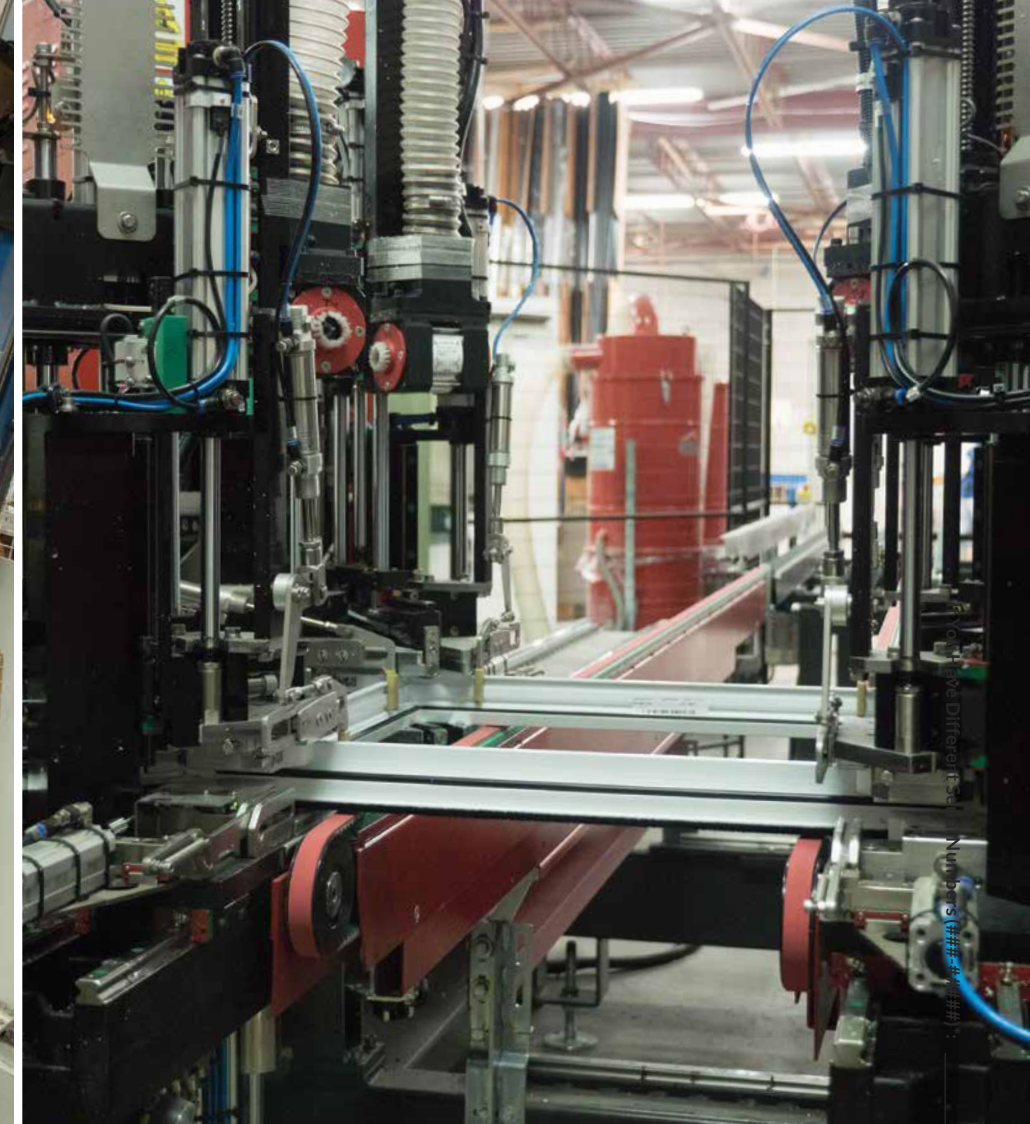



VIEWS THAT INSPIRE